

OPERATING MANUAL

No. 033-7425 EN

SRD-SRC SERIES

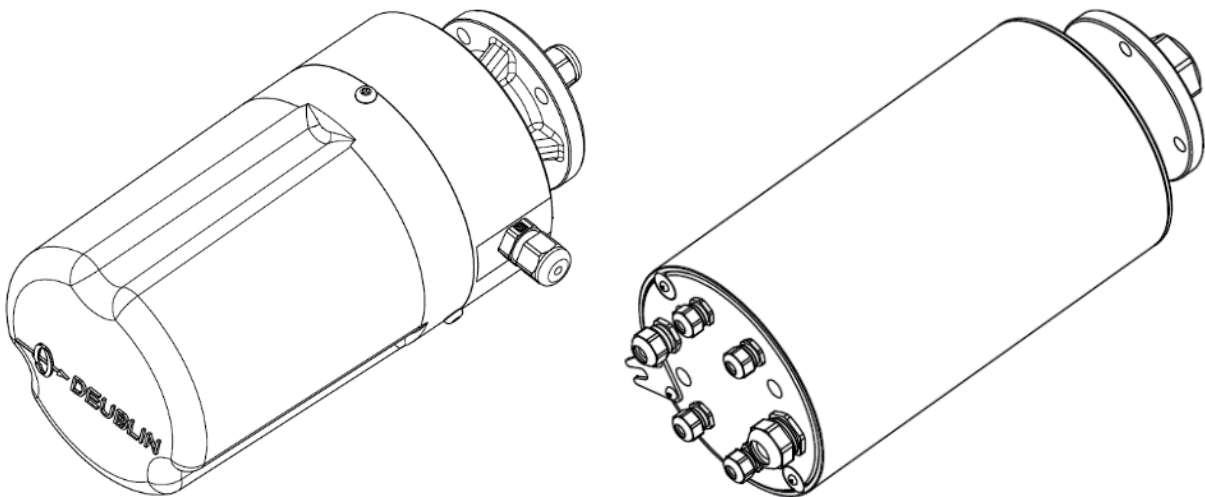

Slip Ring Series

Introduction

This operating manual is intended to be used by operating, maintenance and supervisory personnel.

This operating manual defines general instructions which are to be followed during installation, operation and maintenance of the equipment.

This manual enables personnel to handle the device in a safe and efficient manner. This manual is a part of the device and must be kept in its vicinity in order to ensure that it is available to the personnel at all times.

The operating personnel must have read, understood and must comply with this manual.

Furthermore, all local work protection and general safety regulations applicable at the device's places of installation must be observed.



These instructions are general installation instructions only. Please refer to the installation drawing for specific information pertaining to each installation!

Copyright

This document contains confidential and proprietary information of DEUBLIN Company. Copying, use, transmission, distribution, and disclosure are subject to the terms and conditions contained in your agreement with DEUBLIN Company. All rights reserved.

We deserve our right to do any technical changes which are necessary to improve the product without prior notice.

TABLE OF CONTENTS

1	GENERAL	5
1.1	Structure of symbols	5
1.2	Copyright	6
1.3	Warranty	6
1.4	Customer Service	6
2	SAFETY	7
2.1	Misuse	7
2.2	Basic dangers	7
2.3	Responsibility of the operator	8
2.4	Personnel requirements	8
2.4.1	<i>Qualifications</i>	8
2.4.2	<i>Unauthorized personnel</i>	9
2.4.3	<i>Training</i>	9
2.5	Personal protective equipment	10
2.6	Safety devices	11
3	TECHNICAL DATA	11
3.1	Operating conditions	12
3.2	Product Label or marking	12
4	STRUCTURE AND FUNCTION	13
4.1	Overview	13
4.2	Brief description	14
4.3	Bundle	15
5	TRANSPORT, PACKAGING AND STORAGE	17
5.1	Safety instructions	17
5.2	Inspection at delivery	18
5.3	Packaging	18
5.4	Symbols on the packaging	19
5.5	Transportation	19
5.6	Storage	20
6	INSTALLATION AND START-UP	21
6.1	Safety instruction	21
6.2	Preparations	21
6.3	Installation	22
6.3.1	<i>Assembling the device</i>	22
6.3.2	<i>Slip Ring installation</i>	22
6.3.3	<i>Making electrical connections</i>	24
6.3.4	<i>Reinforcing anti-rotation connection</i>	27
6.4	Initial use	28
6.5	Operation	28
7	MAINTENANCE	28

7.1	Safety instructions.....	28
7.2	Maintenance plan.....	29
7.3	Maintenance work.....	29
7.3.1	<i>Cleaning the device</i>	29
7.3.2	<i>Checking the feed-through lines</i>	30
7.3.3	<i>Checking the outer body</i>	30
8	FAULTS	31
8.1	Safety instructions.....	31
8.2	Fault indicators	31
8.3	Behaviour in case of faults	31
8.4	Fault table.....	32
9	DISMANTLING AND DISPOSAL	32
9.1	Safety instructions.....	32
9.2	Dismantling.....	33
9.3	Disposal.....	34







1 GENERAL

1.1 Structure of symbols

Safety instructions

Safety instructions are marked with symbols in these instructions.

The safety instructions are introduced with signal words, which express the level of endangerment.

 Danger!	DANGER: This combination of symbol and signal word indicates an immediately dangerous situation that can cause death or severe injuries if it is not avoided.
 Warning!	WARNING: This combination of symbol and signal word indicates a possibly dangerous situation that can cause death or severe injuries if it is not avoided.
 Caution!	CAUTION: This combination of symbol and signal word indicates a possibly dangerous situation that can cause slight injuries if it is not avoided.
 Notice!	NOTICE: This combination of symbol and signal word indicates a possibly dangerous situation that can cause property and environmental damage if it is not avoided.
 Info	INFO: This symbol highlights useful tips and recommendations as well as information designed to ensure efficient and smooth operation.
 Danger!	DANGER: This combination of symbol and signal word indicates an immediately dangerous situation due to electric shock. If an instruction so marked is not heeded, severe or fatal injuries can be a consequence.

1.2 Copyright



The copyright as to this manual remains with DEUBLIN. Subject to changes!

- You can download the latest version of this manual under www.deublin.eu.
- Always use the latest version of the operating manual.

1.3 Warranty

The warranty provisions are included in the manufacturers general terms and conditions.

In order to be able to make warranty claims, the device must be sent to the manufacturer.

 Notice!	<p>Warranty is immediately invalid by a third-party service!</p> <p>The warranty is for defects in material or workmanship only and requires evidence that the unit was always operated within the operating conditions and atmosphere defined in the agreed specifications.</p> <ul style="list-style-type: none"> - An extended warrantee requires a complete and unbroken chain of documentation that the device was operated under the agreed parameters and environment. - Wearing parts are excluded. - Under an approved and accepted warranty case Deublin will decide between a device exchange or a device repair at an approved Deublin facility. - For devices serviced by a third party the warranty will become invalid with immediate effect.
 Info	<p>Subject to change without prior notice</p>

1.4 Customer Service

Our customer service is available to you for technical information:

Address	Deublin Italiana Srl Via Guido Rossa, 9 40053 – Monteveglio – Bologna Italy
Telephone	+39 051 835601
Fax	+39 051 832091
E-mail	info@deublin.it
Internet	www.deublin.it

We are always interested in information and experience which arise from use and could be valuable for the improvement of our products.

2 SAFETY

This section provides an overview of all safety aspects that are essential to the best possible protection of the personnel along with the safe and trouble-free operation of the machine.

Additional safety instructions for specific work tasks are contained in the sections regarding the individual life stages of the machine.

2.1 Misuse

This chapter provides information on known misuse of slip ring devices. Slip rings are not suitable for areas and applications described herein. Use in such areas or for such applications constitutes a misuse endangering people and machines and is therefore prohibited.

 Warning!	<p>Danger as a result of misuse!</p> <p>Misuse of the slip ring can cause dangerous situations.</p> <ul style="list-style-type: none">- Never connect the coded connections incorrectly.- Never exceed the power limits.- Never step on or apply side force to the device.- Never operate the device without earthing equipment conductor (PE) with operating voltages greater than 120 VDC or 50 VAC.- If the cable is damaged, de-energize the device immediately.
---	---

2.2 Basic dangers

The following section describes remaining risks which can arise from the device even with proper use. In order to reduce the risk of personal injury and property damage, and to avoid dangerous situations, follow the safety instructions listed below and in other sections of these instructions.

Electric power

 Danger!	<p>Danger to life from electric power!</p> <p>If live parts of the device are touched, there is immediate danger to life, from electric shock. Damage to the insulation or individual components can be life threatening.</p> <ul style="list-style-type: none">- Only allow work on the electrical system to be performed by qualified personnel.- In case of damage to the insulation, de-energize the device immediately and repair before use- Before beginning work on active parts of electrical systems and equipment, de-energize and secure for the duration of the work.- Keep humidity away from energized parts. Condensation will cause an electrical short circuit.
--	---

Rotating parts

 Warning!	<p>Danger of injury due to rotating parts!</p> <p>Rotating parts of the device can cause severe injuries due to winding up, pulling in or catching.</p> <ul style="list-style-type: none">- Do not reach into or hang on rotating parts during operation.- Before all work near rotating parts, stop the rotation and secure against switching on.- In the danger zone, wear close-fitting protective clothing.
---	--

2.3 Responsibility of the operator

The operator is the person who operates the device for commercial or business purposes or allows it to be used/applied by a third party and during operation bears the legal product responsibility for the protection of the user, the personnel or the third party.

For commercial application, the operator of the device is subject to the legal occupational safety requirements.

Here, the following points apply:

- The operator must be knowledgeable about the applicable occupational safety regulations and determine in a hazard assessment which dangers arise due to the special working conditions in the place where the device is used. The operator must implement these in the form of operating instructions for the operations of the device.
- The operator must check during the entire time the device is used, whether the operating instructions which he has created correspond to the current state of the regulations, and, if necessary, adapt these.
- The operator must clearly regulate and specify the responsibility of the installation, operation, trouble shooting, maintenance and cleaning.
- The operator must ensure that all people who handle the device have read and understood these instructions. In addition, he must train the personnel at regular intervals and inform them about the dangers.
- The operator must provide the personnel with the required protective equipment and ensure that they wear the required protective equipment.

Furthermore, the operator is responsible for ensuring that the device is always in technically sound condition.

2.4 Personnel requirements

2.4.1 Qualifications

The various tasks described in these instructions pose different requirements of the qualification of the people who are entrusted with these tasks.

 Warning!	<p>Danger from insufficient qualification of personnel!</p> <p>Insufficiently qualified people cannot assess the risk in handling the device and subject themselves and other people to the danger of severe or deadly injuries.</p> <ul style="list-style-type: none">- Only allow all work to be performed by people qualified to perform it.- Keep insufficiently qualified people out of the work area.
---	---

Here below list of people qualified for various tasks:

Electrician

Due to his professional knowledge, training and experience, as well as his knowledge of the applicable standards and regulations, the electrician is in a position to perform work on electrical systems and to detect and avoid possible danger by himself.

Manufacturer

Particular work may only be performed by the manufacturer's trained personnel. Other personnel are not authorized to perform this work. To have the necessary work performed, contact our customer service.

2.4.2 Unauthorized personnel

 Warning!	<p>Risk to life for unauthorized personnel due to hazards in the danger and working zone!</p> <p>Unauthorized personnel who do not meet the requirements described here below, will not be familiar with possible dangers in the working zone.</p> <p>Therefore, those people could face the risk of serious injury or death.</p> <ul style="list-style-type: none">- Unauthorized personnel must be kept away from the danger and working zone.- If doubt occurs, address the personnel in question and ask them to leave the danger zone.- Stop working while unauthorized personnel are in the danger and working zone.
---	---

2.4.3 Training

The owner must train personnel on a regular basis. Execution of the training must be logged for better traceability, i.e date of training, trained person, content of training.

2.5 Personal protective equipment

Please use protective equipment in order to protect people from hazards to their safety and health while working.

The personnel must wear protective equipment while working on and with the device which is referred specially on the individual sections of these instructions.

Personal protective equipment description:

Personal protective equipment is explained here below:

Safety footwear (Steel toe shoes)



Safety footwear protect the feet from injuries due to falling parts and slipping on a slippery surface.

Safety gloves



Safety gloves are intended to protect hands against friction, abrasion, stabs or deeper wounds and against direct contact with hot surfaces.

2.6 Safety devices

 Warning!	<p>Danger to life from non-functional safety devices!</p> <p>If safety devices are not functioning or are disabled, there is a danger of serious injury or death.</p> <ul style="list-style-type: none">- Check that all safety devices are fully functional and correctly installed, before starting work.- Never disable or bypass safety devices- Ensure that all safety devices are always accessible.
---	---

Potential equalization, earth leakage circuit breaker

After installation, the device must be connected to the local earth (Ground, PE) circuit connector (as described in paragraph 2.1), to prevent arcing when connecting the earth leakage circuit breaker and contact voltage in case of fault.

 Warning!	<p>Danger to life from contact voltage and ignition sparks!</p> <p>Absent or faulty potential equalization may result in contact voltage and ignition sparks. In turn, this may pose a risk of injury or death.</p> <ul style="list-style-type: none">- Before the initial use of the appliance or machine, connect to the equipotential bus bar and verify the complete functionality of the potential equalization.
---	--

3 TECHNICAL DATA

Technical data for the device, such as maximum current, maximum voltage, maximum rotation speed, weight and other performance data, depend on the specific model.

For this information, see the order documents and, if necessary, the included drawings.

A data sheet is available for standard devices.

Drawings are available for special models.

 Info	<p>The specified device weights apply, unless specified otherwise, without the weight of the pre-assembled cables.</p>
---	--

3.1 Operating conditions

Environment

- Temperature range: -20 to +80°C (from -30°C for the Low Temperature version)
- Maximum relative humidity, non-condensing: 0 to 80%
- International protection class: IP65
- Rotation sense: Bi-directional
- Mounting position: Horizontal / Vertical

3.2 Product Label or marking

The product label or marking is placed on the housing and includes the following details:

- Manufacturer
- Product model number
- Serial number
- Work order number
- Country of origin
- Date of production



Model number

DEUBLIN's internal identification / date of manufacture

MADE IN <<country of manufacture>

Serial number

4 STRUCTURE AND FUNCTION

4.1 Overview

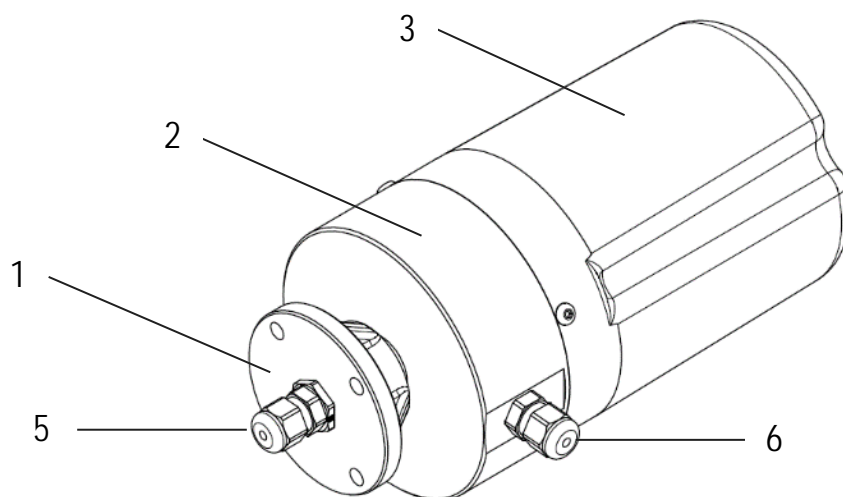

Fig.1: Overview on SRD Model

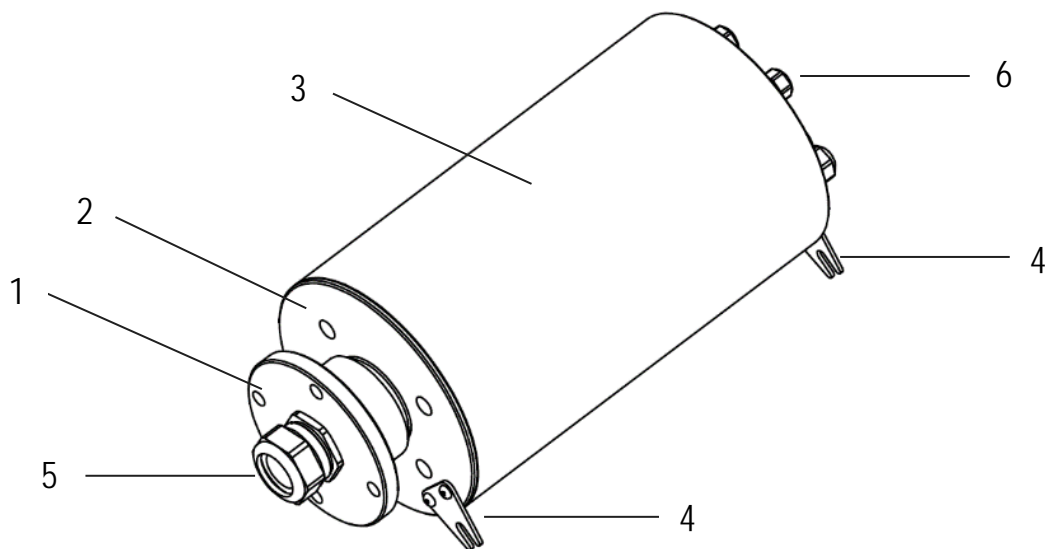

Fig.2: Overview on SRC Model

- 1 – Rotor
- 2 – Stator / Housing
- 3 – Cover
- 4 – Anti-rotation
- 5 – Cable exit: rotor side
- 6 – Cable exit: stator side

4.2 Brief description

The device serves to transmit electrical power, signals and data from various bus systems.

The precious metal brush contact along with the gold-plated conductor rings allow the device to achieve very good power, signal and data transmission properties, combined with a long service life and compact design.

The Precious metal and gold technology provides the perfect surface quality, the greatest possible contact quality and resistance to corrosion with very low transfer resistance.

The standard device belongs in the international protection class IP65.

The device can be combined with other media feedthroughs.

Technical properties

- Reliable transmission of power, signal and data streams
- Very low transfer resistance
- High contact safety
- Very low electrical noise
- Nearly wear-free due to low contact forces
- Long service life without mechanical maintenance
- Operating safety even in case of vibrations and extreme temperatures

Models

- With and without central bore
- Numbers of pins and contacts may vary in modular configurations
- Mechanical and electrical connections can be adapted according to customer specifications
- Generally, enclosed in an aluminum structure
- Rotor coupling directly on the shaft, via flange or insertion shaft connection
- Plug connector (option)
- Low temperature version (option)

4.3 Bundle

The bundle construction allows the combination of the device with other media feedthroughs from the same manufacturer. Thus, the device can be combined for the transmission of the electric current and air, gas, oil, water and/or grease. Bundle a slip ring with a DEUBLIN rotary joint for media transmission stationary to rotary systems.

The optimal sealing technology is used depending on the specific medium.

Advantage of the bundle technology

- Modular structure
- No limit for the media to be transmitted
- Complete solution from a single source
- No interface problems between individual components
- Can be combined with other manufacturers' component
- Compact solution because of coupling optimization

Safety



Info

Be sure to follow the additional system operating instruction of the bundle, union side.

Through the combination with other components, and the feedthrough of other media, there can be additional hazards:



Warning!

Danger of burning from hot surfaces!

The rotating unions are heated by the temperature of the medium. Skin contact with heated rotating unions can cause injuries.

- Use safety gloves and PPE (Personal Protective Equipment) protecting against heat when handling the rotating union.
- Attach a clearly visible danger sign visibly on or next to the rotating union in order to warn of danger.
- If possible, let the component cool off before all work.



Warning!

Danger by improper hoses!

For the connection of the rotating union to the machine, you have to choose appropriate hoses for the respective medium which meet the specifications for the application. If you use incorrect hoses, they may become porous or burst. This can cause personal injury and/or property damage to components of the machine.

- In the case of the medium being hydraulic oil, use hoses which are suitable for the maximum system pressure of the machine and the maximum temperature of the media.





Warning!

Danger by faulty installation!

If the rotating unions are installed incorrectly, hoses and connections may become leaky. The medium can escape. Depending on the medium, personal injury or property damage to the components of the machine may occur.

- Before installing the rotating union ensure that no feed pressure and no residual pressure is applied to the pipeline system of the machine.
- Install the rotating union on the machine using hoses only, in order to avoid stress on the rotating union.
- Install the hoses so they do not apply stress to the unit.
- Install the hoses to the rotating union prior to mounting the rotating union to the machine shaft.

 Warning!	Danger of burning from hot media! When working on the rotating union, injuries can be caused by skin or eye contact with the media. <ul style="list-style-type: none">- Observe the safety instructions for the flow media. Observe the COSHH (Control of Substances Hazardous to Health) Safety Data Sheet for the flow media
---	--

 Warning!	Danger of injury due to rotating parts! Due to the combination of several rotating components and their torque supports, there may be new hazard points which can cause injury. See also required operating instructions for the rotary union sealing system in question. <ul style="list-style-type: none">- Perform risk assessment- If necessary, install or adapt separating protective device.- See the other required operating instructions for the rotary union sealing system in question.
---	--

 Info	If necessary, the operator must take additional measures
--	--

5 TRANSPORT, PACKAGING AND STORAGE

5.1 Safety instructions

Suspended loads

 Warning!	Danger of fatal injury by suspended loads! During lifting operations loads may swing out and fall down. This may result in serious injury or death. <ul style="list-style-type: none">- Never step under suspended loads, and do not step within their pivoting range.- Only move loads under supervision.- Only use approved hoists and lifting gear with a sufficient load-bearing capacity.- Do not use torn or abraded lifting devices such as ropes and straps.- Do not place a lifting device such as ropes and straps against sharp edges or corners and do not knot or twist them.- Set the load down when leaving the workplace.
---	--

Improper transport

 Notice!	<p>Damage to property due to improper transport!</p> <p>Moving units may fall or tip over as a result of improper transport. This can cause significant property damage.</p> <ul style="list-style-type: none">- Proceed carefully when unloading units at delivery and during in-house transport: observe symbols and instructions on the packaging.- Only use the lifting points provided.- Only remove the packaging shortly before assembly.
--	---

5.2 Inspection at delivery

On receipt, immediately inspect the delivery for completeness and transportation damage.

Proceed as follows in the event of externally apparent transportation damage.

- Do not accept the delivery, or only accept it subject to reservation.
- Note the extent of the damage on the transport documentation of the shipper's delivery note.
- Initiate complaint procedures.

 Info	<p>Issue a complaint with respect to each defect immediately following detection. Damage compensation claims can only be asserted within the applicant complaint deadlines.</p>
---	---

5.3 Packaging

About packaging

The individual containers are packaged in accordance with anticipated transport conditions. Only environmentally-friendly materials have been used in the packaging.

The packaging is intended to protect the individual components from transportation damage, corrosion and other damage prior to assembly. Therefore do not destroy the packaging and only remove it shortly before assembly.

Handling of packaging materials

Either keep packaging material for a later use to shipping or storage of the device according to the respectively valid legal provisions and local regulations.

 Notice!	<p>Damage to the environment due to incorrect disposal!</p> <p>Packaging materials are valuable raw materials and can, in many cases, be used again or prepared sensibly and recycled. Incorrect disposal may pose risk to the environment.</p> <ul style="list-style-type: none">- Dispose of packaging materials in an environmentally-friendly way.- Heed the local disposal regulations. If necessary, entrust a certified specialist with the disposal.
--	--

5.4 Symbols on the packaging

The following symbols can be affixed to the packaging. Always heed the symbols during the transportation.

Protect against moisture



Protect against moisture and keep dry

Fragile



Marks packages with fragile or sensitive contents.

Recycle



Recycle packaging material after product removal

5.5 Transportation

Depending on the model of the device, transportation with a forklift may be necessary.

Transportation of pallets with the forklift

Transport of pieces which are fastened on pallets can, under the following conditions, be transported with a forklift:

- The forklift must be designed for the weight of the transport pieces.
- The transport piece must be fastened securely to the pallet.
- The forklift driver must be authorized according to the locally applicable regulations to drive fork conveyors with a driver's seat or a driver's stand.

Transport



- Drive the forklift with the forks between or under the rails of the pallet.
- Insert the forks so they protrude of from the opposite side.
- Ensure that the pallet cannot tip if the center of gravity is not in the middle.
- Lift the pallet with the transport piece and begin the transport.

5.6 Storage

The device contains plastic elements whose properties can be changed by environmental influences such as oxygen, ozone, heat, light, UV, rays and solvents.

Store the device under the following conditions:

- Do not store near heating elements or other sources of heat.
- Do not store in the same rooms with solvents, chemicals, acids, fuels, disinfectants or similar substances.
- Do not store in proximity to fluorescent light sources, mercury vapor lamps, light sources, electric motors or devices that can generate sparks or an ozone charge due to other electrical discharges.
- Do not subject to direct sunlight or open installed fluorescent tubes which can generate UV load.
- Do not place on copper, brass or rusty steel.
- Store dry and dust-free.
- If possible, store in air and light-resistant original packaging and only unpack shortly before use.
- Storage temperature range: 0°C to 40°C
- Spare seals: store voltage free, do not bend, fold, knick, hang on hooks or expose to pressure loads.
- Maximum storage time: 12 months. After that, send back to manufacturer for inspection.



Info

Under some circumstances, there are notes about storage on the packaging pieces which exceed the requirements specified here. Adhere to these accordingly.

6 INSTALLATION AND START-UP

6.1 Safety instruction

	<p>Danger to life from electric power!</p> <p>If live parts of the electric device are touched, there is immediate danger to life from electric shock.</p> <ul style="list-style-type: none">- Only allow work on the electrical system to be performed by an electrician.- Before any work, switch off the machine or system in which the device should be installed and secure against switching on again.- Before any work, switch off power and data lines and secure against switching on again.- Before any work, check the system to ensure that it is de-energized.- Before the start-up of the device, connect it to the local earth (Ground, PE) circuit connector and verify the complete functionality of the potential equalization.
--	--

 <p>Caution!</p>	<p>Danger of injury due to component weight!</p> <p>If the device falls down during assembly, it can injure hands or feet due to its weight.</p> <ul style="list-style-type: none">- Handle the device carefully. Do not let it fall. If necessary, secure it with a suitable hoisting device- Wear safety shoes (steel toe shoes)
---	--

6.2 Preparations

Personnel

- Electrician
1. Switch off the machine or system in which the device should be installed and secured against switching on again. Block possible mechanical movements.
 2. Disconnect the electrical power feed and the data lines and secure against switching on again.
 3. If necessary, disconnect the supply of compressed air and other media and secure against switching on again.
 4. Check the entire installation environment of the device to ensure that it is de-energized and de-pressurized. Switch off and secure adjacent live parts.

6.3 Installation

6.3.1 Assembling the device

 Notice!	<p>Property damage due to incorrect assembly of the device!</p> <p>Improper assembly can cause property damage to the device.</p> <ul style="list-style-type: none">- The device may never be simultaneously clamped radially on the exterior diameter and screwed via the shaft. This destroys the bearing of the rotary feedthrough.- Centering and screw-in threads must be worked precisely and aligned, and during installation they must be free of dirt and foreign bodies.
--	--

Personnel

- Electrician

Protective equipment:

- Safety footwear (steel toe shoes)
- Safety gloves

Special tools:

- Allen key
- Spanner

6.3.2 Slip Ring installation

 Caution!	<p>CAUTION: Always read relevant installation drawings to identify components and their position!</p>
---	--

1. Use always the coupling flange to connect the device mechanically.
2. Be sure that the cable clamp is correctly positioned and cables bending radius are according to cable specifications.

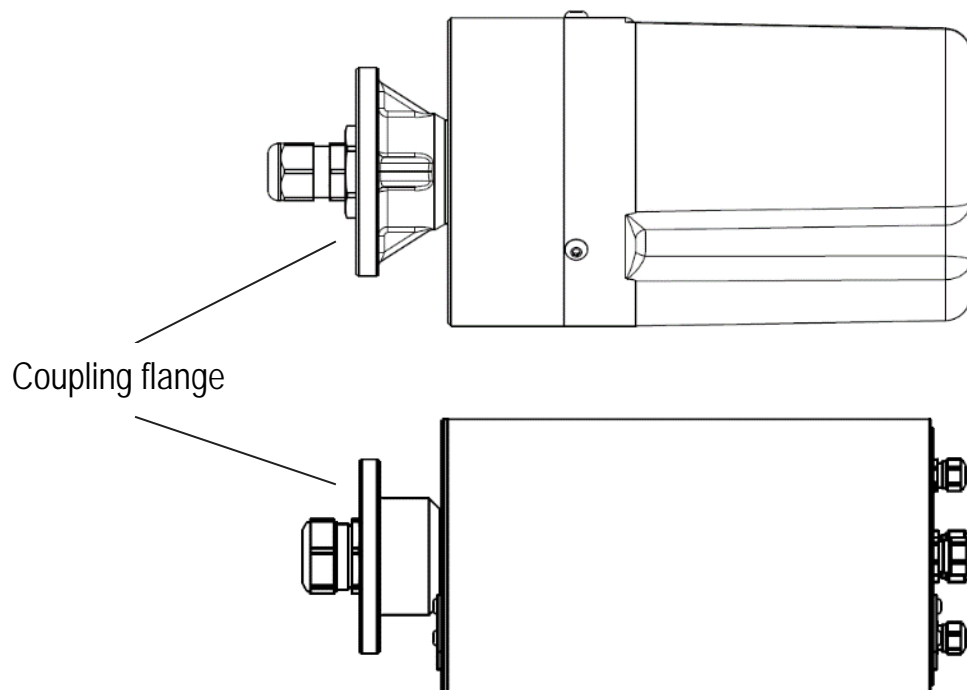



Fig.3: Coupling flange for connection

**Caution!****Always hold the device firmly by hands during the installation!**

Always make sure that the device will not fall down, hitting the ground or surrounding obstacles.

Never hold the device by means of the cables only.

6.3.3 Making electrical connections

 Danger!	Danger to life from electric power! In case of overload of the electrical components, there is immediate danger to life due to electric shock. <ul style="list-style-type: none">- Heed the nominal power capacity of the device
--	---

 Info	If an earthing equipment conductor (PE) is required for operation, the PE connection or the green-yellow cable must first be connected to the system's earthing equipment conductor.
---	--

There are various connection types available. On the housing and rotor side, various connection types can be combined.

Personnel

- Electrician

Special tools and parts

- Cable stripper
- ferrules
- Pliers

6.3.3.1 Fixed connection

The cables are soldered inside the device and cannot be removed.

1. Feed the shaft-side cable through the holes provided in the rotary feedthrough.
2. Attach plug connectors or ferrules to individual wire ends.

6.3.3.2 Connections of plug connectors

Two cases must be distinguished.

Case 1

On the slip rings, there are flange sockets appropriate for the plug connectors provided on the shaft and/or housing.

Personnel

- Electrician
- Connect plug connectors supplied by the customer to these flange sockets.

Case 2

Plug connectors are attached to the cable that is soldered permanently to the housing.

Personnel

- Electrician
- Connect the plug connectors with corresponding pieces supplied by the customer.

6.3.3.3 Connection with spring clamp

Using spring clamp terminal blocks as shaft-side contacting for the cables on the device, the rotary feedthrough and the device can be separated without having to unclamp the cable on the machine side.

Personnel

- Electrician

Special tools and parts

- Cable stripper
- ferrules
- Pliers
- Screwdriver

1. Strip outer insulation and screening of the cable to a length of 1x device exterior diameter.



Info

Always connect PE first

2. Press ferrules onto individual wires of the cable .
3. Push individual wire ends with ferrules into corresponding slots in the terminal block according to the numbering sequence.



Info

In order to release individual wires of the cable from the spring clamps, push the tip of the screwdriver into the notch in the spring clamp over the cable feed opening. The corresponding wire of the cable can be then pulled out.

6.3.3.4 Connection on SRD-SRC

Follow steps written in 6.3.3.3 if the case.

Personnel

- Electrician

Special tools and parts

- Cable stripper
- ferrules
- Pliers
- Screw driver



Info

Before making electric connections, make sure that the device is firmly connected to the shaft of the machine side.

1. Push individual wire ends with ferrules into corresponding slots in the terminal block according to the numbering sequence, on shaft side.
2. Keep enough room for cables, avoiding any excess of pulling on them.

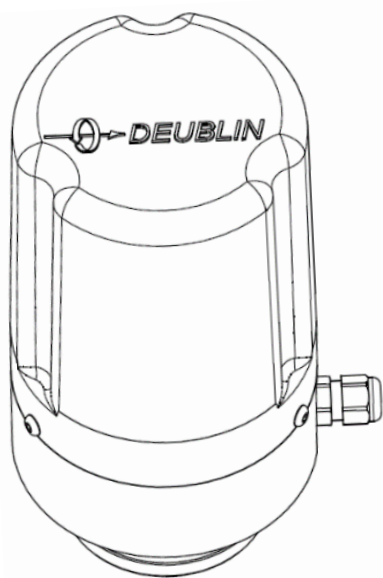

6.3.4 Reinforcing anti-rotation connection

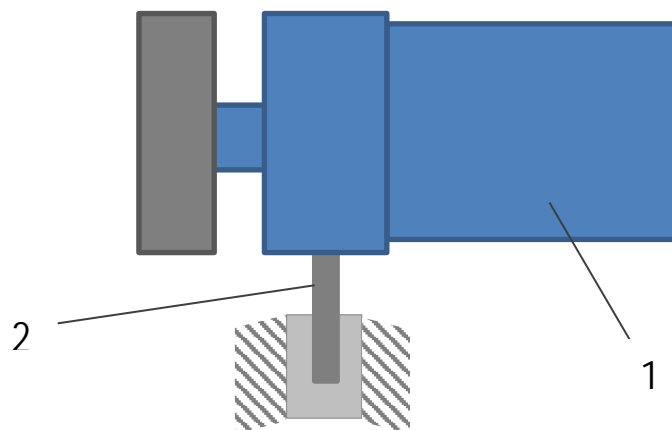

Fig.5: Schematic example of an anti-rotation connection

1. Device housing
2. Anti-rotation pin

The operating-conditioned torque must be absorbed using a tension-free torque support. The support comes from a radial, tension free synchronization of the torques.

Personnel

- Electrician

Special tools

- Ring or fixed spanner

	<p>The housing of the device may not be blocked by screwing the housing or the anti-rotation to the machine.</p> <p>A device holding only via cables is not sufficient.</p>
---	---

1. Connect the device and anti-rotation support using the threaded holes in the housing.

	<p>Danger of injury due to moving parts!</p> <p>Due to the arrangement of the anti-rotation support there is a danger of severe personal injury.</p>
---	---

2. Carry out a risk assessment to assess the actual danger and, if necessary, secure danger points with separating safety equipment.

6.4 Initial use

Personnel

- Electrician

1. Check all screw connections, connections, and separate safety equipment for correct attachment and tight fit. Check feedthrough of the lines.

	Danger of injury due to exceeding of the usage limits! Exceeding of the specified usage limits of the device (Chapter 3 "Technical data") will result in personal injuries and property damage.
---	---

Warning!

2. Increase speed and pressure (Option), slowly, to the desired operating values. Heed the usage limits on the rating plate, the order documents and, if necessary, the included drawing.

6.5 Operation

	The device has no individual operation and can only be used when installed.
--	---

Info

7 MAINTENANCE

7.1 Safety instructions

	Danger to life from electric power! If live parts of the device are touched, there is immediate danger to life, from electric shock. In case of contact with liquids, there can be short circuits. <ul style="list-style-type: none">- Before beginning work, switch off the power supply and secure against switching on again.
---	--

Danger!

	Danger of injury due to mechanical movements! The movement of the system or machine in which the device is installed can cause severe injuries. <ul style="list-style-type: none">- Before beginning any work, stop any mechanical movements and secure against switching on again.
---	---

Warning!



Warning!

Danger of injury due to fed-through media!

The media fed through could be under pressure and can cause severe injuries.

7.2 Maintenance plan

The device is largely maintenance free. No maintenance work can be performed on interior components.

If necessary, adapt cleaning and checking intervals listed in the following maintenance table to the actual operating conditions. In case of questions about maintenance work and intervals, contact the manufacturer.

Have the following work performed according to the maintenance plan of the machine:

- Cleaning the device
- Checking media lines



Info

In case of bundle solution (slip ring and rotary union), always heed the operating instructions for additional components.

7.3 Maintenance work

7.3.1 Cleaning the device



Notice!

Damage to property due to improper cleaning!

The device may never be cleaned with compressed air, steam or water jet devices.

Personnel

- Electrician

Protective equipment

- Safety footwear (steel toe shoes)
- Safety gloves

Materials:

- Clean, dry and lint-free cloth

1. Switch off all mechanical moving parts, electrical lines and media feed lines and secure against switching on again.
2. Clean the exterior of the housing with a clean, dry and lint-free cloth.

7.3.2 Checking the feed-through lines

Personnel

- Electrician

Protective equipment

- Safety footwear(steel toe shoes)
- Safety gloves
- Inspect all cable connections (connectors, cord grips), for damage and replace if necessary.
- Inspect all cable insulation: outer surface of connecting cables must be intact without scratches or damage.

7.3.3 Checking the outer body

Personnel

- Electrician

Protective equipment

- Safety footwear (steel toe shoes)
- Safety gloves
- Check if there are any loosened or missing screws: Tighten or replace in case of missing parts.
- Check if cord grips are loose : tighten in case cables are not holding properly.

8 FAULTS

8.1 Safety instructions

	<p>Danger to life from electric power!</p> <p>If live parts of the device are touched, there is immediate danger to life, from electric shock.</p> <ul style="list-style-type: none">- Before beginning work, de-energize all active parts of electrical systems and equipment, and secure them for the duration of the work.
---	--

Danger!

	<p>Danger of injury due to escaping media!</p> <p>The media escaping under high pressure can cause injuries.</p> <ul style="list-style-type: none">- Before beginning any work, switch off the media supply and secure against switching on again.
---	---

Warning!

8.2 Fault indicators

The following events indicate faults:

- Signal noise
- Increase of torque or housing temperature
- Bearing noises or vibrations

8.3 Behaviour in case of faults

Essentially it applies:

1. In case of faults which represent an immediate danger to people or property values, initiate an emergency off immediately.

	<p>Danger to life from electric power!</p> <p>If live parts of the device are touched, there is immediate danger to life from electric shock.</p> <ul style="list-style-type: none">- The device may not be opened.
---	--

Danger!

2. Insofar as possible, determine the cause of the fault.
3. Inform the responsible people at the site of operation about the fault immediately.
4. Send the device to the manufacturer or dispose of it properly. For contact information see page 6.

8.4 Fault table

Personnel

- Electrician
- Manufacturer

Fault description	Cause	Remedy
No electrical feedthrough	Connection not installed correctly	Electrician: secure connection and check function
Housing short-circuited	Slip ring transmitter soiled	Send device back to manufacturer for cleaning
Malfunction of the device	Slip ring transmitter has jumped out of the slideway	Send device back to manufacturer for adjustment
	Cables in the slip ring are broken	Send device back to manufacturer for adjustment
	Solder point has loosened	Send device back to manufacturer for adjustment
	Slideway is worn	Send device back to manufacturer for adjustment
Feedthrough resistance has increased	Slideway is soiled	Send device back to manufacturer for cleaning
Unusual noises	Foreign body in the slip ring transmitter	Send device back to manufacturer for cleaning
	Bearing damage	Send device back to manufacturer for cleaning

9 DISMANTLING AND DISPOSAL

Once the device has reached the end of its useful life, it must be disassembled and disposed of appropriately.

9.1 Safety instructions

Electrical system

 Danger!	<p>Danger to life from electric power!</p> <p>Contact with live parts may prove fatal. When switched on, electric components may be subject to uncontrolled movements and may cause grave injuries.</p> <ul style="list-style-type: none"> - Before starting the dismantling, switch off the electric power supply and disconnect completely.
--	---

Improper dismantling

 Warning!	<p>Danger of injury due to improper dismantling!</p> <p>Stored remaining energies, sharp components, tips and corners on and in the device, or on the required tools, can cause injuries.</p> <ul style="list-style-type: none">- Handle components with open sharp edges carefully.- Before beginning work, ensure there is sufficient space. Secure components and- tools so that they do not fall down or topple.- Dismantle the components properly. Heed the weight of some of the components. If necessary, use hoisting equipment- In case of ambiguity, contact the manufacturer.
---	--

9.2 Dismantling

Personnel

- Electrician

Protective equipment

- Safety footwear (steel toe shoes)
- Safety gloves

Special tools

- Allen key
- Ring or fixed spanner
- Small flat head screwdriver
- Pliers

1. Switch off and disconnect completely all electrical systems .
2. Loosen all electrical connections.

 Caution!	<p>Danger of crushing due to the component weight!</p> <p>During loosening the screws, the device can fall down and result in personal injuries and property damage.</p>
---	---

Secure the device. If necessary, use a suitable hoisting device or a second person.

3. In order to dismantle the device, depending on the assembly type, loosen the screws on the connection flange or the side clamping screws on the mandrel.
4. Remove the device from the mandrel. While doing so, heel the cables fed through the mandrel. Put the cables eventually together with the device out of the feed-through hole.

9.3 Disposal

If no return or disposal agreement has been made, send the dismantled components for recycling.

- Scrap metals.
- Send plastic elements for recycling.
- Sort and dispose of other components in accordance with their material composition.

	<p>Danger to the environment due to incorrect disposal!</p> <p>Incorrect disposal may pose risk to the environment.</p> <ul style="list-style-type: none">- Electrical scrap, electronic components, lubricants and other auxiliary materials must be disposed of by authorized specialist companies.- If in doubt, obtain information about disposal, in accordance with the environmental regulations from the local municipal authorities or specialized waste disposal companies.
--	---

Notice!

Reliability

Many years' experience, ongoing liaison with customers, innovations sourced inhouse and from suppliers place DEUBLIN in a position providing reliable devices at the highest level.

When it comes to concrete applications, maximum service life is guaranteed by matching the channel solution to the respective current and voltage conditions.

The service life is also equally maximized by maintaining cleanliness when storing and handling the device and by adhering to the guidelines issued by DEUBLIN in respect of the conditions on the customer's premises.

EUROPE

DEUBLIN Germany

Florenz-Allee 1
55129 Mainz, Germany
Phone: +49 6131-49980
Fax: +49 6131-4998109
e-mail: info@deublin.de

DEUBLIN Italy

Via Guido Rossa 9 - Loc. Monteveglio
40053 Comune di Valsamoggia (BO), Italy
Phone: +39 051-835611
Fax: +39 051-832091
e-mail: info@deublin.it

DEUBLIN Austria

Lainzer Straße 35
1130 Wien, Austria
Phone: +43 1-8768450
Fax: +43 1-876845030
e-mail: info@deublin.eu

DEUBLIN France

61 bis, Avenue de l'Europe
Z.A.C de la Malnoue, Emerainville
77436 Marne-la-Vallée Cedex 2, France
Phone: +33 1-64616161
Fax: +33 1-64616364
e-mail: service.client@deublin.fr

DEUBLIN Poland

ul. Kamińskiego 201-219
51-126 Wrocław, Poland
Phone: +48 71-3528152
Fax: +48 71-3207306
e-mail: info@deublin.pl

DEUBLIN Russia

ul. Kosygina, 13, 5th entrance, 1st floor
Moscow, 119334, Russia
Phone: +7 495-647 1434
Fax: +7 495-938 8949
e-mail: info@deublinrussia.ru

DEUBLIN Spain

C/ Lola Anglada, 20 local 1
08228 Terrassa, Spain
Phone: +34 93-221 1223
Fax: +34 93-221 2093
e-mail: deublin@deublin.es

DEUBLIN Sweden

Cylindervägen 18, Box 1113
13 126 Nacka Strand, Sweden
Phone: +46 8-716 2033
Fax: +46 8-601 3033
e-mail: info@deublin.se

DEUBLIN United Kingdom

6 Sopwith Park, Royce Close, West Portway
Andover SP10 3TS, UK
Phone: +44 1264-33 3355
Fax: +44 1264-33 3304
e-mail: info@deublin.co.uk

AMERICA

DEUBLIN USA

2050 Norman Drive
Waukegan, IL 60085-6747 U.S.A
Phone: +1 847-689 8600
Fax: +1 847-689 8690
e-mail: customerservice@deublin.com

DEUBLIN Brazil

Rua Fagundes de Oliveira, 538 - Galpão A11
Piraporinha
CEP: 09950-300 - Diadema - SP - Brasil
Phone: +55 11-2455 3245
Fax: +55 11-2455 2358
e-mail: deublinbrasil@deublinbrasil.com.br

DEUBLIN Mexico

Norte 79-A No. 77, Col. Claveria
02080 Mexico, D.F.
Phone: +52 55-5342 0362
Fax: +52 55-5342 0157
e-mail: deublin@prodigy.net.mx

ASIA

DEUBLIN China

No. 2, 6th DD Street,
DD Port Dalian, 116620, China
Phone: +86 411-8754 9678
Fax: +86 411-8754 9679
e-mail: info@deublin.cn

Shanghai Branch Office

Room 15A07, Wangjiao Plaza
No. 175 East Yan'an Road, Huangpu District
Shanghai 200002
Phone: +86 21-5298 0791
Fax: +86 21-5298 0790
e-mail: info@deublin.cn

DEUBLIN Asia Pacific

51 Goldhill Plaza, #11-11/12
Singapore 308900
Phone: +65 6259-92 25
Fax: +65 6259-97 23
email: deublin@singnet.com.sg

DEUBLIN Japan

2-13-1, Minamihanayashiki, Kawanishi City
Hyogo 666-0026, Japan
Phone: +81 72-757 0099
Fax: +81 72-757 0120
e-mail: customerservice@deublin-japan.co.jp

2-4-10-3F, Ryogoku, Sumida-ku

Tokyo 130-0026, Japan
Phone: +81 3-5625 0777
Fax: +81 3-5625 0888
e-mail: customerservice@deublin-japan.co.jp

1-9-2-4F, Mikawaanjo-cho, Anjo City

Aichi 446-0056, Japan
Phone: +81 566-71 4360
Fax: +81 566-71 4361
e-mail: customerservice@deublin-japan.co.jp

DEUBLIN Korea

Star Tower #1003, Sangdaewon-dong 223-25,
Jungwon-gu, Seongnam-si, Gyeonggi-do,
South Korea
Phone: +82 31-8018 5777
Fax: +82 31-8018 5780
e-mail: customerservice@deublin.co.kr